

ENGINE

Model	Isuzu 4HKIX. European Tier III emissions compliant.
Type	Water cooled, 4-stroke, 4-cylinder in-line, direct injection, turbocharged diesel.
Nett power (ISO 3046-1NF)	129kW (173hp) at 2000rpm.
Piston Displacement	5.193 litres.
Injection	Electronic injection.
Air Filtration	Dry element with secondary safety element and in cab warning indicator.
Cooling	Water cooler via large capacity radiator.
Starter motor	24 volt – 4.5kW.
Batteries	2 x 12 volt Heavy-duty.
Alternator	24 volt 40 amp.
Refuelling pump	Electric type.

SWING SYSTEM

Swing motor	Axial piston.
Swing brake	Hydraulic braking plus automatic spring applied disc type parking brake.
Final drive	Planetary reduction.
Swing speed	12.9rpm.
Swing gear	Large diameter, internally toothed fully sealed grease bath lubricated.
Swing lock	Switchable brake in cab.

UNDERCARRIAGE

Carriage options	SC-Standard, NC-Narrow and LC-Long Carriage.	
Construction	Fully welded, "X" frame type with central bellyguarding and track motor guards. Sloping sidemembers with dirt relief holes under top rollers. Front and rear.	
Recovery point	Sealed and greased.	
Track type	NC & SC – 500mm (20in), 600mm (24in), 700mm (28in). LC – 600mm (24in), 700mm (28in), 800mm (31.5in), 900mm (36in).	
Track shoe options	Heat treated, sealed and lubricated.	
Upper & lower rollers	Grease cylinder type.	
Track adjustment	Sealed and lubricated, with spring cushioned recoil.	
Track idler	NC & SC	LC
No. of track guides	2 per side	2 per side
No. of lower rollers	7 per side	8 per side
No. of upper rollers	2 per side	2 per side
No. of track shoes	46 per side	49 per side

ENVIRONMENT

Noise levels	LwA external: dBA 103 LwA operator ear: dBA 72
---------------------	---

HYDRAULICS

A variable flow load sensing system with flow on demand, variable power output and servo operated, multi-function open centre control. Machine auto warm up standard – maximises performance in cold conditions.

Pumps

Main pumps	2 variable displacement axial piston type.
Maximum flow	2 x 214 L/min (2 x 47 UK GPM).
Servo pump	Gear type.
Maximum flow	20 L/min (4.4 UK GPM).

Control valve

A combined four and five spool control valve with auxiliary service spool as standard. When required twin pump flow is combined to boom, dipper and bucket services for greater speed and efficiency.

Relief valve settings

Boom/Arm/Bucket	343 bar (4975 lbf/sq.in)
Automatic power boost	373 bar (5410 lbf/sq.in)
Swing circuit	289 bar (4190 lbf/sq.in)
Travel circuit	343 bar (4975 lbf/sq.in)
Pilot control	40 bar (580 lbf/sq.in)

A separate Cushion Control valve in the servo system provides cushioning of the boom and dipper spools selection and quick warm-up of the servo system.

Hydraulic cylinders

Double acting type, with bolt-up end caps and hardened steel bearing bushes. End cushioning is fitted as standard on boom, dipper and bucket rams.
Optional hose burst check valves available for boom and dipper rams.

Filtration

The hydraulic components are protected by the highest standard of filtration to ensure long hydraulic fluid and component life.

In tank	150 micron, suction strainer.
Main return line	10 micron, fibreform element.
Plexus Bypass line	1.5 micron, paper element.
Pilot line	10 micron, paper element.
Hydraulic hammer return	10 micron, reinforced microform element.

Cooling

Cooling is provided via a full return line air blast cooler as part of a single face cooling pack in conjunction with the engine water cooler.

TRACK DRIVE

Type	Fully hydrostatic, three speed with autoshift between high and medium speed.
Travel motors	Variable swash axial piston type, fully guarded within undercarriage frame.
Final drive	Planetary reduction, bolt-on sprockets.
Service brake	Hydraulic counter balance valve to prevent overspeeding on gradients.
Park brake	Disc type, spring applied, automatic hydraulic release.
Gradeability	70% (35 deg) continuous.
Travel speed	High – 5.6 km/h (3.4 mph). Mid – 3.3 km/h (2.1 mph). Low – 2.3 km/h (1.4 mph).
Tractive effort	191.9kN (19570 kgf, 43144 lbf).

DRIVES AND BRAKES

Steering control	Twin pedal and levers giving independent track control
Drive method	Hydrostatic
Travel operation	3 speed with automatic shift between medium and high speed
Gradeability	70% 35°
Maximum travel speeds	Low – 2.3 km/h (1.4 mph) Medium – 3.3 km/h (2.1 mph) High – 5.6 km/h (3.4 mph)
Tractive effort	202.3 kN (20629/45479 kgf/lbf)
Brake system	Hydraulically operated discs in each travel motor

EXCAVATOR END

Monoboom available along with a choice of dipper lengths to suit the requirements of reach, dig-depth, loadover height, tearouts and site versatility. Reserve strength is built into the fully welded structures for hydraulic hammer and other arduous operations. Fabricated bucket tipping links are provided with a choice of lift points. Strong, durable construction, large cross sections and multi plate fabrications to withstand high stress applications. The 5.7m (18ft 8in) boom is designed to ensure the optimum digging envelope when matched with the three dipper lengths. Low maintenance bronze alloy bushes with graphite plugs are fitted to boom base and boom to dipper pivots resulting in 1000 hour greasing intervals at these points.

CAB

Excellent digging, loading and positioning visibility results from the careful design of front, side and roof lights. All screens are tinted to improve in cab conditions. Fully opening front screen is very smooth to operate and as the lower screen is stored in rear of cab. Fresh air ventilation available from opening door window, opening slot in front screen and fully opening front screen. Parallelogram wash wiper for upper screen ensuring good wiped area for maximum visibility. Wiper motor is fitted in the left hand side of the roof screen so as not to affect bucket visibility when loading. Optional lower screen wiper available. Fresh air ventilation and heater with windscreen demister. Infinitely variable blower speed, temperature and recirculation control. Optional climate control. Fully adjustable deluxe suspension seat with arm rest adjustment and backrest recline. Optional radio with digital tuner fitted into the roof lining for maximum protection. Conveniently placed radio mute button incorporated into lower console. 12v power point and mobile phone holder built into the right hand console. Courtesy light can be operated from ground level and is illuminated for five minutes or until switched off improving operator access at night. Cab mounted roller blind protects operator from suns' glare through front or top screens.

SERVICE CAPACITIES

Fuel tank	litres (UK gal)	343 (75.4)
Radiator	litres (UK gal)	25.5 (5.61)
Engine oil	litres (UK gal)	17.5 (3.85)
Swing drive	litres (UK gal)	5.0 (1.1)
Hydraulic tank	litres (UK gal)	120 (26.4)
Final drive (each side)	litres (UK gal)	4.7 (1.0)

AMS – ADVANCED MANAGEMENT SYSTEM

Four selectable working modes link the operators control movements with the engine and hydraulic systems to maximise productivity and efficiency.

- A (Auto)** Up to 100% engine power and 100% flow. Gives variable power and speed depending on the operator's input, matching the demand for output and efficiency to the job. Power boost is automatically activated in this mode should hard conditions be encountered. Auto idle cuts in after a period of inactivity (between 5 and 30 seconds as set by the operator)
- E (Economy)** 80% engine power. 95% of hydraulic flow maximises economy while maintaining excellent output.
- P (Precision)** 55% engine power. 90% of hydraulic flow for fine control of grading operations.
- L (Lifting)** 55% engine power. 63% of hydraulic flow with permanent power boost for maximum lifting power and control.

The Auto mode allows the AMS processor to select the optimum operational performance to match the demands of the job while the three alternative modes give precise matching of application when specific tasks are undertaken.

The adjustable position monitor mounted on the front right hand pillar of the cab gives the operator a constant read out of mode, tracking range, operating temperature and a host of other information, while retaining excellent visibility of the monitor and the job being carried out.

The required flow for hammer applications can be set and stored in the AMS memory and is automatically activated whenever the hammer pedal is depressed.

A maintenance indicator warns of imminent service needs, and all servicing and basic checks can be carried out using only the in cab display.

CONTROLS

- Excavator Tracks** All servo lever operated to ISO control pattern, independently adjustable to the seat. Individually servo operated by foot pedal or hand lever. Speed selection via joystick button.
- Auxiliary Control isolation** Via servo operated foot pedal. Via gate lock lever at cab entrance or panel switch.
- Engine speed** Dial type throttle control plus servo lever mounted one-touch idle control or separate selectable auto-idle with adjustable time delay using AMS.
- Engine stop** Ignition key operated and separate shut-down button.
- Horn** Operated via servo lever mounted button.

STATIC DIMENSIONS – JS220 NLC/SC/LC MONOBOOM

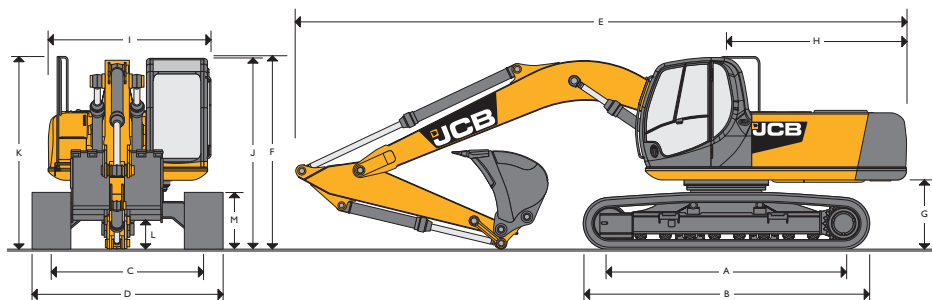

Dimensions in millimetres (ft-in)	NLC	SC	LC
A Track length on ground	3660 (12-0)	3370 (11-1)	3660 (12-0)
B Undercarriage overall length	4460 (14-6)	4170 (13-8)	4460 (14-8)
C Track gauge	1990 (6-6)	2200 (7-2)	2390 (7-10)
D Width over tracks (500mm trackshoes)	2490 (8-2)	2700 (8-10)	-
D Width over tracks (600mm trackshoes)	2590 (8-6)	2800 (9-2)	2990 (9-10)
D Width over tracks (700mm trackshoes)	2690 (8-10)	2900 (9-6)	3090 (10-2)
D Width over tracks (800mm trackshoes)	-	-	3190 (10-6)
D Width over tracks (900mm trackshoes)	-	-	3290 (10-10)
Dipper lengths	1.91m (6ft 3in)	2.40m (7ft 10in)	3.0m (9ft 10in)
E Transport length with Monoboom	9570 (31-5)	9560 (31-4)	9440 (31-0)
F Transport height with Monoboom	3055 (10-0)	3060 (10-0)	3025 (9-11)
G Counterweight clearance			1066 (3-6)
H Tailswing radius			2825 (9-3)
I Width of superstructure			2549 (8-4)
J Height over cab			2946 (9-8)
K Height over grab rail			3025 (9-11)
L Ground clearance			486 (1-7)
M Track height			885 (2-11)

WEIGHTS AND GROUND BEARING PRESSURES

Figures include 1.14cu.m. bucket 760kg (1675lbs), operator, full fuel tank, 600mm track shoes and 2.4m dipper.

MONOBOOM		500mm shoes	600mm shoes	700mm shoes	800mm shoes	900mm shoes
JS220NLC						
Machine weight	kg (lb)	21144 (46615)	21396 (47170)	21648 (47725)	-	-
Ground bearing pressure	kg/cm (lb/ft ²)	0.51 (7.25)	0.43 (6.11)	0.37 (5.26)	-	-
JS220SC						
Machine weight	kg (lb)	21227 (46800)	21479 (47350)	21731 (47900)	-	-
Ground bearing pressure	kg/cm (lb/ft ²)	0.51 (7.25)	0.43 (6.11)	0.37 (5.26)	-	-
JS220LC						
Machine weight	kg (lb)	-	21904 (48290)	22172 (48880)	22440 (49470)	22490 (49580)
Ground bearing pressure	kg/cm (lb/ft ²)	-	0.41 (5.83)	0.36 (5.12)	0.31 (4.41)	0.28 (3.98)

BUCKET AND ARM FORCE

Arm length		1.91m (6ft 3in)	2.40m (7ft 10in)	3.00m (9ft 10in)
Bucket digging force	kg (lb)	14550 (32080)	14550 (32080)	14550 (32080)
Bucket digging force at Power boost	kg (lb)	15800 (34835)	15800 (34835)	15800 (34835)
Arm crowd force	kg (lb)	13450 (29650)	11560 (25485)	9590 (21142)
Arm crowd force at Power boost	kg (lb)	14610 (32210)	12550 (27670)	10410 (22950)

STANDARD EXCAVATING BUCKETS

JS220 Mono Boom Bucket and Arm combination		600 (24)	900 (24)	1000 (39)	1200 (47)	1350 (53)	1450 (57)	1500 (59)
Bucket width	mm (in)							
Bucket capacity	m ³ (yd ³)	0.40 (0.52)	0.71 (0.93)	0.81 (1.06)	1.03 (1.35)	1.05 (1.37)	1.14 (1.49)	1.19 (1.56)
Bucket weight	kg (lb)	484 (1067)	595 (1312)	627 (1382)	705 (1555)	679 (1497)	720 (1588)	734 (1618)
Undercarriage and Dipper length								
JS220NLC	1.91m (6ft 3in)	○	○	○	○	○	○	○
JS220NLC	2.40m (7ft 10in)	○	○	○	○	○	●	●
JS220NLC	3.00m (9ft 10in)	○	○	○	●	●	■	■
JS220SC	1.91m (6ft 3in)	○	○	○	○	○	○	○
JS220SC	2.40m (7ft 10in)	○	○	○	○	○	○	○
JS220SC	3.00m (9ft 10in)	○	○	○	○	○	●	●
JS220LC	1.91m (6ft 3in)	○	○	○	○	○	○	○
JS220LC	2.40m (7ft 10in)	○	○	○	○	○	○	○
JS220LC	3.00m (9ft 10in)	○	○	○	○	○	○	○

○ Material weight up to 2000kg/m³ (1.50t/yd³) ● Material weight up to 1800kg/m³ (1.35t/yd³) ■ Material weight up to 1500kg/m³ (1.1t/yd³)

These recommendations are given as a guide based on typical operating conditions.

Please contact your distributor for the correct selection of buckets and attachments to suit the application.

WORKING RANGE – JS220 NLC/SC/LC MONOBOOM

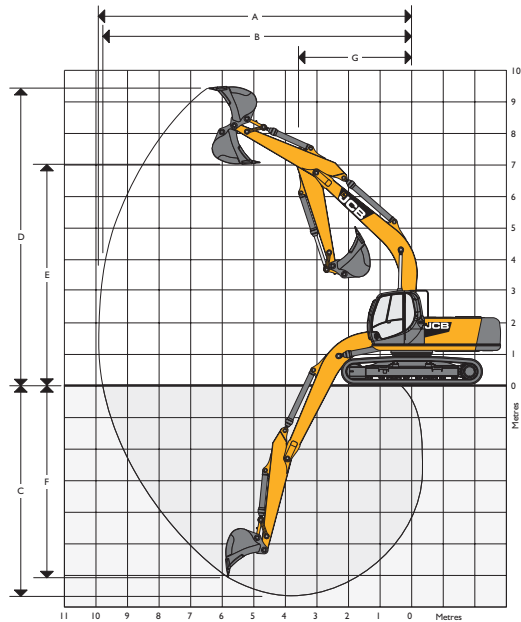

WORKING RANGE – JS220 NLC/SC/LC MONOBOOM

Boom length 5.70m (18ft 8in)					
Dipper length		1.91m (6ft 3in)	2.40m (7ft 10in)	3.00m (9ft 10in)	
A	Maximum digging reach	m (ft-in)	8.89 (29-2)	9.34 (30-8)	9.87 (32-5)
B	Maximum digging reach (on ground)	m (ft-in)	8.70 (28-7)	9.16 (30-1)	9.70 (31-10)
C	Maximum digging depth	m (ft-in)	5.53 (18-2)	6.02 (19-9)	6.60 (21-8)
D	Maximum digging height	m (ft-in)	8.95 (29-4)	9.20 (30-2)	9.40 (30-10)
E	Maximum dumping height	m (ft-in)	6.31 (20-8)	6.53 (21-5)	6.75 (22-2)
F	Maximum vertical wall cut depth	m (ft-in)	4.90 (16-1)	5.47 (17-11)	6.07 (19-11)
G	Minimum swing radius	m (ft-in)	3.76 (12-4)	3.71 (12-2)	3.60 (11-10)
	Bucket rotation	deg.	183°	183°	183°
	Dipper tearout (ISO 6015)	kgf (lbf)	13450 (29650)	11560 (25485)	9590 (21142)
	Dipper tearout with boost (ISO 6015)	kgf (lbf)	14610 (32210)	12550 (27670)	10410 (22950)
	Bucket tearout (ISO 6015)	kgf (lbf)	14550 (32080)	14550 (32080)	14550 (32080)
	Bucket tearout with boost (ISO 6015)	kgf (lbf)	15800 (34835)	15800 (34835)	15800 (34835)

STANDARD EQUIPMENT

Isuzu 4KH1X 128kW common rail, turbocharged intercooled direct injection EU Stage III and EPA Tier 3 compliant engine; Dual element type air cleaner with in-cab warning system; Automatic fuel system de-aeration; Automatic engine warm-up system; Engine overheat prevention/warning system; Automatic engine deceleration/idle function; AMS machine monitor system; 4 selectable work modes – Auto, Economy, Lifting, Precision; Remote engine oil level check; Plexus filtration system; Servo oil filtration system; Dual fuel intake filters with additional water separator; 3 speed travel system; High back suspension seat; Overload warning device; Horn; Upper and lower underguarding; Lockable service doors and engine cover; Frame mounted toolbox; Remote greasing for slew bearing; Electric refuelling pump; Handrails with non-slip walkways; Boom and mainframe mounted worklights; Toolkit; Quick connect engine oil drain; Remote mounted easy access filters; Cushion control; Operators manual.

Auto operator cab – Pressurised; Tinted safety glass with sun visor; Opening front window; Operator storage shelf with cargo net; Ashtray and cigarette/mobile phone charger socket; Mobile phone holder; Radio mute switch; Courtesy light; Heater and demister; Removable floor mat.

OPTIONAL EQUIPMENT











SC, LC and NLC undercarriages; 500, 600, 700, 800 and 900mm triple grouser track plates; Monoboom or T.A.B.; 1.91m, 2.4m and 3.0m dippers; Auxiliary pipework (full and lowflow), quick release couplings for auxiliary pipework, shut-off valves for auxiliary pipework; Hose burst check valves; Tipping link mounted lift points; FOPS (Level II) protection system; Mesh screen guard; Additional worklights; ISO 63 or ISO 32 hydraulic oils; Bio oil; Lower wiper; Rain visor (not available with FOPS protection or mesh screen guard); Climate control; Heated and suspension high backed seat; Radio; Fire extinguisher; Widecore radiator; Visibowl or Turbo II precleaner; P3 or carbon cab air intake filter; Travel alarm; Quickhitch pipework; JCB buckets or attachments. NB: Long Reach option available – please ask your dealer for more information.

ATTACHMENTS

Surelock Hydraulic Quickhitch	
Hammermaster	HM1570Q, HM1760Q
GP Buckets	Cat style teeth – 610mm, 762mm, 914mm, 1067mm, 1219mm ESCO tooth system – 550mm, 850mm, 950mm, 1150mm, 1300mm, 1400mm, 1450mm
Heavy Duty Buckets	ESCO tooth system – 550mm, 850mm, 1150mm, 130mm
Grading Buckets	1542m, 1830mm, 2058mm
Selector Grab	SG700 – capacity 700l
Rockwheel	RW100N – 1058mm (42in) cutting width
Multiprocessor	MP200
Crusher Bucket	CB70 30m³/h











LIFT CAPACITIES – Dipper length: 1.9m, Monoboom 5.7m, Trackshoes: 500mm, No bucket.

JS220 NLC MONO

Reach	3m (9ft 10in)		4.5m (14ft 9in)		6m (19ft 8in)		7.5m (24ft 7in)		Max. Reach		Max. Reach
											
Load Point Ht.	kg	kg	kg	kg	kg	kg	kg	kg	kg	kg	mm
6.0m (19.8ft)					6380*	4750			5720*	4620	6105
4.5m (14.9ft)			8020*	7030	6720*	4650			5700*	3770	6907
3.0m (9.10ft)			9870*	6550	7250	4470			5410	3380	7318
1.5m (4.11ft)			10850	6210	7060	4290			5230	3260	7406
0m			10720	6110	6950	4200			5420	3350	7182
- 1.5m (- 4.11ft)	13010*	11410	10750	6130	6940	4190			6080	3720	6614
- 3.0m (- 9.10ft)	12760*	11580	9650*	6270					7600*	4710	5596











LIFT CAPACITIES – Dipper length: 2.4m, Monoboom 5.7m, Trackshoes: 500mm, No bucket.

JS220 NLC MONO

Reach	3m (9ft 10in)		4.5m (14ft 9in)		6m (19ft 8in)		7.5m (24ft 7in)		Max. Reach		Max. Reach
											
Load Point Ht.	kg	kg	kg	kg	kg	kg	kg	kg	kg	kg	mm
7.5m (24.7ft)									5230*	5230*	5547
6.0m (19.8ft)					5810*	4840			4790*	3990	6767
4.5m (14.9ft)			7330*	7150	6290*	4710			4690	3360	7497
3.0m (9.10ft)			9230*	6680	7110*	4510	5240	3290	4800*	3060	7878
1.5m (4.11ft)			10820*	6290	7080	4320	5140	3200	4730	2950	7959
0m			10740	6120	6940	4190	5080	3150	4860	3020	7751
- 1.5m (- 4.11ft)	10850*	10850*	10710	6090	6900	4160			5340	3300	7229
- 3.0m (- 9.10ft)	14090*	11440	10270*	6180	6980	4230			6250	3980	6313
- 4.5m (- 14.9ft)			7500*	6440					6850	5960	4777

LIFT CAPACITIES – Dipper length: 3.0m, Monoboom 5.7m, Trackshoes: 500mm, No bucket.

JS220 NLC MONO



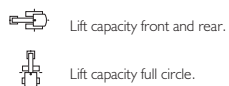







Reach	3m (9ft 10in)		4.5m (14ft 9in)		6m (19ft 8in)		7.5m (24ft 7in)		Max. Reach		Max. Reach
											
Load Point Ht.	kg	kg	kg	kg	kg	kg	kg	kg	kg	kg	mm
7.5m (24.7ft)					4350*	4350*			3440*	3440*	6285
6.0m (19.8ft)					5170*	4930			3210*	3210*	7382
4.5m (14.9ft)					5740*	4780	5190*	3410	3160*	3040	8056
3.0m (9.10ft)	11580*	11580*	8380*	6820	6630*	4560	5270	3310	3230*	2780	8411
1.5m (4.11ft)			10200*	6370	7120	4340	5150	3200	3430*	2690	8488
0m	6400*	6400*	10750	6120	6940	4180	5060	3120	3800*	2730	8293
- 1.5m (- 4.11ft)	10510*	10510*	10650	6040	6860	4110	5030	3090	4470*	2940	7807
- 3.0m (- 9.10ft)	15320*	11230	10700	6080	6880	4130			5600	3440	6969
- 4.5m (- 14.9ft)	12460*	11530	8920*	6250					6760*	4670	5619



- Notes:
1. For lifting capacity including bucket, subtract total weight of bucket or bucket and quickhitch from above values.
 2. Lifting capacities are based on ISO 10567, that is: 75% of minimum tipping load or 87% of hydraulic lift capacity, whichever is the less. Lifting capacities marked* are based on hydraulic capacity.
 3. Lift capacities assume that the machine is on firm, level ground.
 4. Lift capacities may be limited by local regulations. Please refer to your dealer.











LIFT CAPACITIES – Dipper length: 1.9m, Monoboom 5.7m, Trackshoes: 600mm, No bucket.

JS220 SC MONO

Reach	3m (9ft 10in)		4.5m (14ft 9in)		6m (19ft 8in)		7.5m (24ft 7in)		Max. Reach		Max. Reach
											
Load Point Ht.	kg	kg	kg	kg	kg	kg	kg	kg	kg	kg	mm
6.0m (19.8ft)					6380*	5250			5720*	5100	6105
4.5m (14.9ft)			8020*	7820	6720*	5140			5700*	4170	6907
3.0m (9.10ft)			9870*	7320	7340	4950			5480	3750	7318
1.5m (4.11ft)			10990	6980	7150	4780			5300	3610	7406
0m			10860	6870	7040	4680			5490	3720	7182
- 1.5m (- 4.11ft)	13010*	13010*	10890	6890	7040	4680			6160	4140	6614
- 3.0m (- 9.10ft)	12760*	12760*	9650*	7030					7600*	5250	5596











LIFT CAPACITIES – Dipper length: 2.4m, Monoboom 5.7m, Trackshoes: 600mm, No bucket.

JS220 SC MONO

Reach	3m (9ft 10in)		4.5m (14ft 9in)		6m (19ft 8in)		7.5m (24ft 7in)		Max. Reach		Max. Reach
											
Load Point Ht.	kg	kg	kg	kg	kg	kg	kg	kg	kg	kg	mm
7.5m (24.7ft)									5230*	5230*	5547
6.0m (19.8ft)					5810*	5330			4790*	4400	6767
4.5m (14.9ft)			7330*	7330*	6290*	5200			4690*	3710	7497
3.0m (9.10ft)			9230*	7460	7110*	4990	5310	3640	4800*	3380	7878
1.5m (4.11ft)			10820*	7060	7180	4800	5210	3550	4790	3270	7959
0m			10880	6880	7040	4670	5150	3490	4930	3350	7751
- 1.5m (- 4.11ft)	10850*	10850*	10850	6860	7000	4640			5240	3670	7229
- 3.0m (- 9.10ft)	14090*	13140	10270*	6950	7080	4710			6610	4430	6313
- 4.5m (- 14.9ft)			7500*	7210					6850*	6660	4777

LIFT CAPACITIES – Dipper length: 3.0m, Monoboom 5.7m, Trackshoes: 600mm, No bucket.

JS220 SC MONO



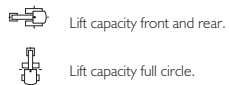







Reach	3m (9ft 10in)		4.5m (14ft 9in)		6m (19ft 8in)		7.5m (24ft 7in)		Max. Reach		Max. Reach
											
Load Point Ht.	kg	kg	kg	kg	kg	kg	kg	kg	kg	kg	mm
7.5m (24.7ft)					4350*	4350*			3440*	3440*	6285
6.0m (19.8ft)					5170*	5170*			3210*	3210*	7382
4.5m (14.9ft)					5740*	5270	5190*	3760	3160*	3160*	8056
3.0m (9.10ft)	11580*	11580*	8380*	7610	6630*	5050	5340	3670	3230*	3080	8411
1.5m (4.11ft)			10200*	7140	7210	4830	5220	3560	3430*	2990	8488
0m	6400*	6400*	10890	6880	7030	4660	5130	3470	3800*	3040	8293
- 1.5m (- 4.11ft)	10510*	10510*	10790	6800	6950	4590	5090	3440	4470*	3270	7807
- 3.0m (- 9.10ft)	15320*	12920	10770*	6840	6980	4610			5680	3820	6969
- 4.5m (- 14.9ft)	12460*	12460*	8920*	7020					6760*	5210	5619



- Notes:
1. For lifting capacity including bucket, subtract total weight of bucket or bucket and quickhitch from above values.
 2. Lifting capacities are based on ISO 10567, that is: 75% of minimum tipping load or 87% of hydraulic lift capacity, whichever is the less. Lifting capacities marked* are based on hydraulic capacity.
 3. Lift capacities assume that the machine is on firm, level ground.
 4. Lift capacities may be limited by local regulations. Please refer to your dealer.











LIFT CAPACITIES – Dipper length: 1.9m, Monoboom 5.7m, Trackshoes: 700mm, No bucket.

JS220 LC MONO

Reach	3m (9ft 10in)		4.5m (14ft 9in)		6m (19ft 8in)		7.5m (24ft 7in)		Max. Reach		Max. Reach
											
Load Point Ht.	kg	kg	kg	kg	kg	kg	kg	kg	kg	kg	mm
6.0m (19.8ft)					6380*	5800			5720*	5640	6105
4.5m (14.9ft)			8020*	8020*	6720*	5700			5700*		
3.0m (9.10ft)			9870*	8200	7470*	5500			5980*		
1.5m (4.11ft)			11210*	7840	8160	5320			6010		
0m			11510*	7730	8050	5220			6230		
- 1.5m (- 4.11ft)	13010*	13010*	11040*	7750	8040	5220			7010		
- 3.0m (- 9.10ft)	12760*	12760*	9650*	7900					7600*		











LIFT CAPACITIES – Dipper length: 2.4m, Monoboom 5.7m, Trackshoes: 700mm, No bucket.

JS220 LC MONO

Reach	3m (9ft 10in)		4.5m (14ft 9in)		6m (19ft 8in)		7.5m (24ft 7in)		Max. Reach		Max. Reach
											
Load Point Ht.	kg	kg	kg	kg	kg	kg	kg	kg	kg	kg	mm
7.5m (24.7ft)									5230*	5230*	5547
6.0m (19.8ft)					5810*	5810*			4790*	4790*	6767
4.5m (14.9ft)			7330*	7330*	6290*	5750			4690*	4110	7497
3.0m (9.10ft)			9230*	8330	7110*	5540	6010	4040	4800*	3750	7878
1.5m (4.11ft)			10820*	7930	7930*	5340	5910	3950	5120*	3640	7959
0m			11480*	7740	8040	5220	5840	3890	5580	3730	7751
- 1.5m (- 4.11ft)	10850*	10850*	11300*	7720	8000	5180			6150	4080	7229
- 3.0m (- 9.10ft)	14090*	14090*	10270*	7810	7560*	5250			6980*	4930	6313
- 4.5m (- 14.9ft)			7500*	7500*					6850*	6850*	4777

LIFT CAPACITIES – Dipper length: 3.0m, Monoboom 5.7m, Trackshoes: 700mm, No bucket.

JS220 LC MONO

Reach	3m (9ft 10in)		4.5m (14ft 9in)		6m (19ft 8in)		7.5m (24ft 7in)		Max. Reach		Max. Reach
											
Load Point Ht.	kg	kg	kg	kg	kg	kg	kg	kg	kg	kg	mm
7.5m (24.7ft)					4350*	4350*			3440*	3440*	6285
6.0m (19.8ft)					5170*	5170*			3210*	3210*	7382
4.5m (14.9ft)					5740*	5740*	5190*	4160	3160*	3160*	8056
3.0m (9.10ft)	11580*	11580*	8380*	8380*	6630*	5600	5810*	4060	3230*	3230*	8411
1.5m (4.11ft)			10200*	8010	7560*	5370	5920	3950	3430*	3320	8488
0m	6400*	6400*	11240*	7740	8040	5210	5820	3860	3800*	3380	8293
- 1.5m (- 4.11ft)	10510*	10510*	11410*	7660	7960	5130	5790	3830	4470*	3650	7807
- 3.0m (- 9.10ft)	15320*	14880	10770*	7700	7980	5160			5790*	4260	6969
- 4.5m (- 14.9ft)	12460*	12460*	8920*	7890					6760*	5810	5619

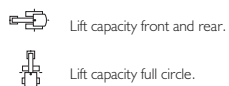

- Notes:
1. For lifting capacity including bucket, subtract total weight of bucket or bucket and quickhitch from above values.
 2. Lifting capacities are based on ISO 10567, that is: 75% of minimum tipping load or 87% of hydraulic lift capacity, whichever is the less. Lifting capacities marked* are based on hydraulic capacity.
 3. Lift capacities assume that the machine is on firm, level ground.
 4. Lift capacities may be limited by local regulations. Please refer to your dealer.